

MORGAN PRODUCTS

PNEUMATIC CHEMICAL PUMPS FOR THE GAS AND OIL INDUSTRIES

Setup and Features Model 375DS

All stainless steel construction. Standard plunger material is 17-4 stainless with Titanium Nitride coating. Titanium Nitride is an extremely hard ceramic material. All fluid components are 316 SS, air drive is a mix of 300 series stainless. Standard pressure seal is Graphite filled Teflon. Check valves have Teflon seats. Piston return spring is Teflon coated for increased performance. All pumps are individually tested for performance and quality.

INSTALLATION INSTRUCTIONS

1. Discard all red plastic closures.
2. Connect suction check valve, to a gravity fed chemical source.
3. Connect discharge check valve, to process line.
4. Connect a regulated air or gas supply, to the timing relay.
5. Open bleeder valve until chemical flows from bleeder.
6. Set regulator at 10 to 15 psi ABOVE the pressure required.
(See discharge pressure graph).
7. Set cycle rate in strokes per minute.

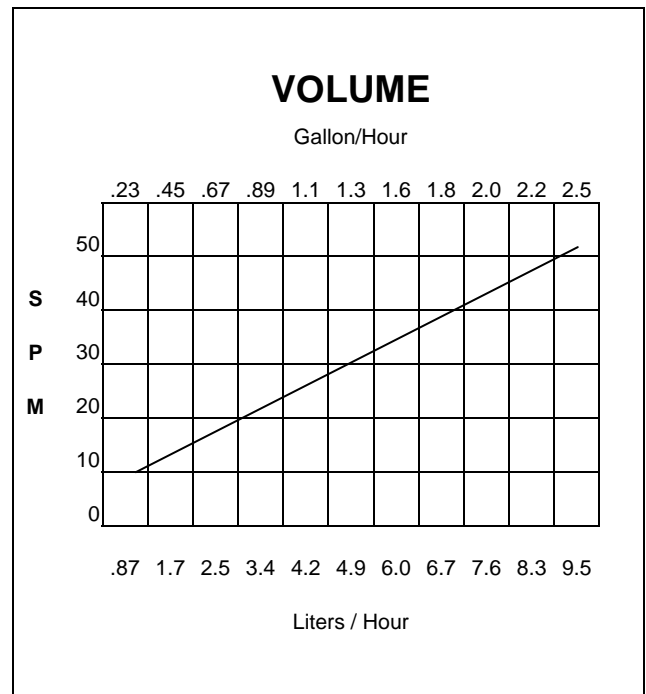
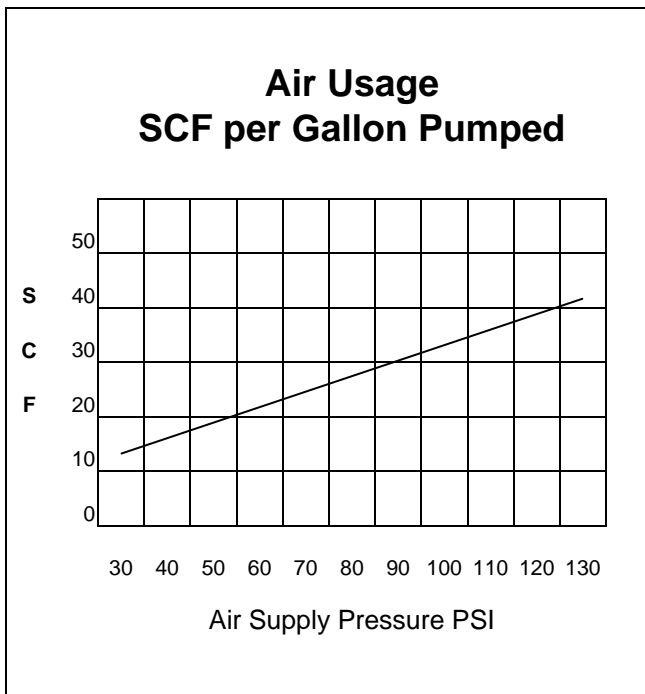
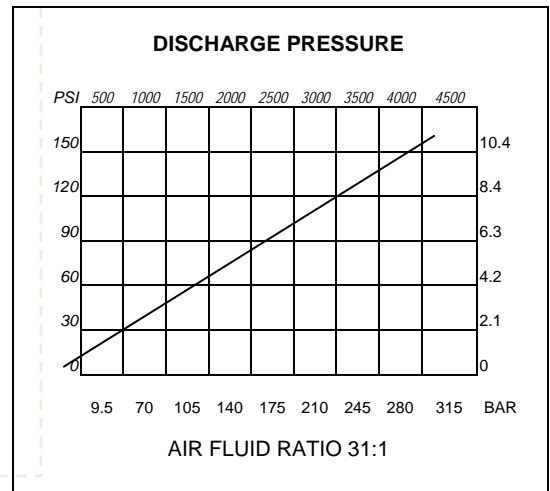

MORGAN PRODUCTS INC. 28103 Avenue Stanford / Valencia, CA 91355

(661) 257-3022 / (800) 421-8910 / Fax (661) 257-3385

MORGAN PRODUCTS

PNEUMATIC CHEMICAL PUMPS FOR THE GAS AND OIL INDUSTRIES

Parts List Model 275DS / 375DS / 475DS

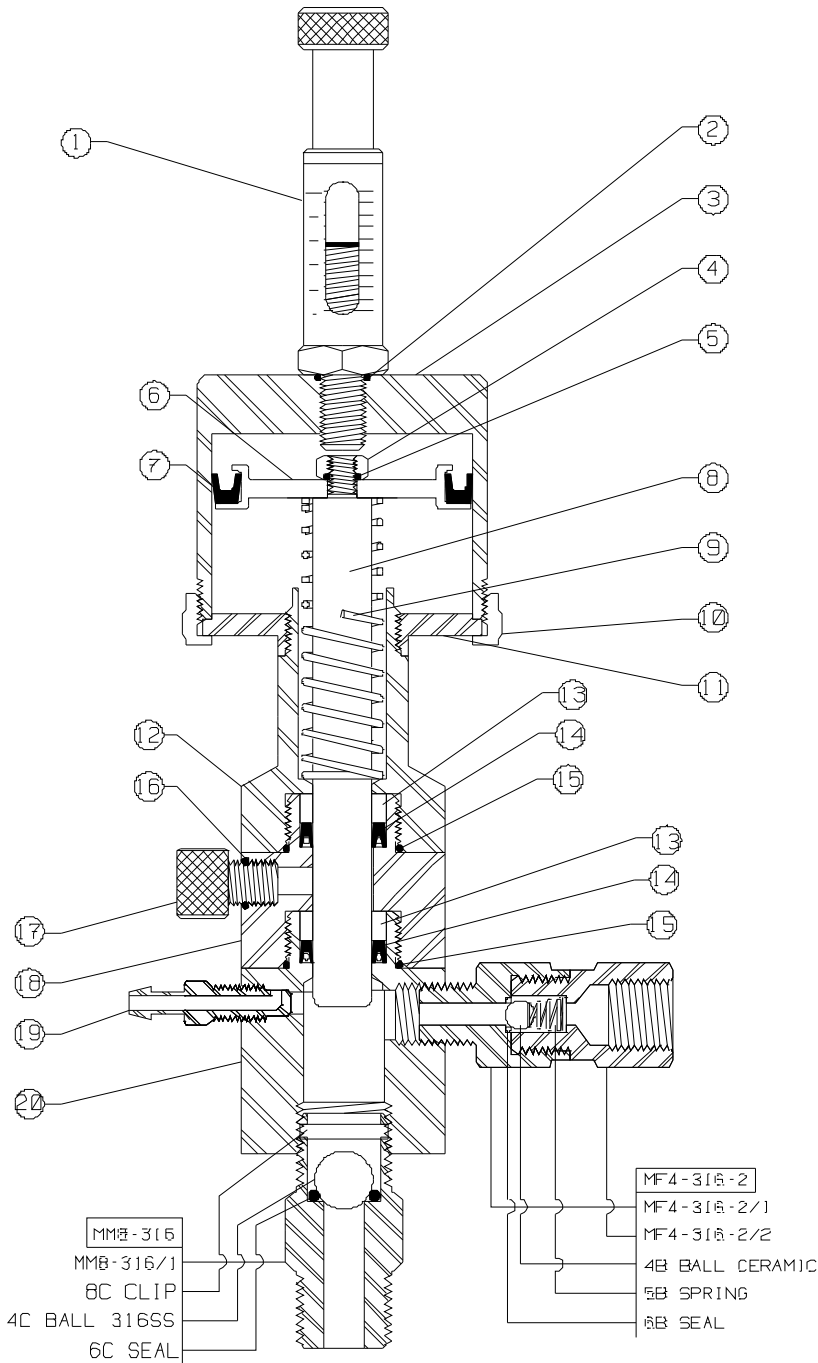

NO	NAME	PART NO.	PUMP MODEL
1	Stroke Adjuster	100-1B	ALL
2	O-Ring Seal	100-3 *	ALL
3	Air Chambers	200-4 300-4 400-4	275DS 375DS 475DS
4	Piston Locknut	100-7	ALL
5	O-Ring Seal	100-11 *	ALL
6	Pistons	200-8 300-8 400-8	275DS 375DS 475DS
7	Piston Seals	200-9 * 300-9 * 400-9 *	275DS 375DS 475DS
8	Plungers: 17-4 TN Standard Optional 316 SS Carpenter 20	250-65 *	ALL
9	Return Spring	250-13 *	ALL
10	Air Chamber Ring	200-5 300-5 400-5	275DS 375DS 475DS
11	Face Plates	220-6 300-6 400-6	275DS 375DS 475DS
12	Oil Chamber	250-14	ALL
13	Back Up Ring	250-19 *(2)	ALL
14	Pressure Seals: TG Standard Optional Buna-N Viton Fluoraz	250-20 +*(2) 250-20B 250-20V 250-20F	ALL
15	O-Ring Seal	100-21 *(2)	ALL
16	O-Ring Seal	100-11	ALL
17	Grease Plug	125-31	ALL
18	Double Seal Body	275-64	ALL
19	Bleeder Plug	125-22	ALL
20	Fluid Chamber	275-23	ALL
	1/3 oz. Grease	*	ALL
	Elbow	400-27	475DS
	Lock Screw	400-28 (2)	475DS
	1/4" Washer	400-29 (2)	475DS
	Repair Kits: 17-4TN Plunger 316 Plunger	250-70 350-70 450-70 275-70 375-70 475-70	* = Included in Repair Kit
	Seal Sets: TG Buna-N Viton Fluoraz	250-48 250-48B 250-48V 250-48F	+ = Included in Seal Set

MORGAN PRODUCTS INC. 28103 Avenue Stanford / Valencia, CA 91355

(661) 257-3022 / (800) 421-8910 / Fax (661) 257-3385